

HB03 UFO LED HIGH BAY



* Product features:

- High-quality LEDs provided by Samsung/ Seoul Semiconductor/ Nichia/ Lumiled and driver designed by Rang Dong with excellent performance
- High efficacy up to 140 lm/W
- Die-cast aluminum heatsink design with perfect heat dissipation
- PC optical lens with high lighting transmittance and desired lighting distribution
- IP65, IK08
- 0-10 V dimming
- CE, KC certified
- Long lifespan: 30,000 hours/ 50,000 hours, saving the maintenance cost
- Options:
 - + Voltage: 120/ 220÷240/ 100÷277V
 - + Driver: non-isolated/ isolated

* Applications:

- Warehouses, factories, stadiums, tunnels, etc..



PRODUCT DETAILS

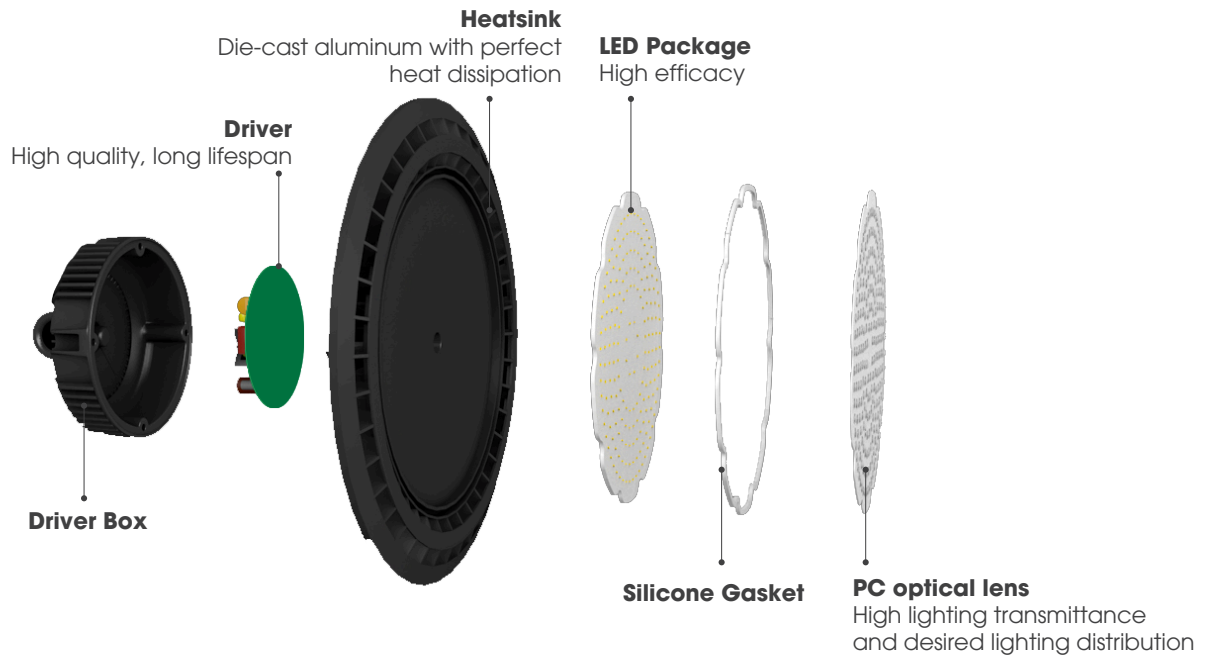

PRODUCT SPECIFICATIONS

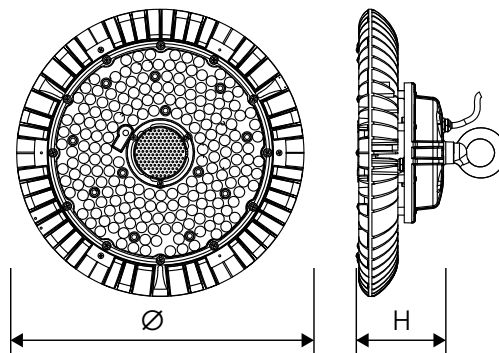

Model	Dimension ØxH (mm)	Power (W)	Voltage (V)	Power factor	Luminous flux (lm)	Luminous Efficacy (lm/W)	CCT (K)	CRI (Ra)	Beam angle (°)	Lifespan (hrs)
HB03 290/100W	290x160	100	120/220÷240/100÷277	0,9	12000/13000	120/130	3000/4000/6500	80	90	30,000/50,000
HB03 350/120W	345x160	120	120/220÷240/100÷277	0,9	14400/15600	120/130	3000/4000/6500	80	90	30,000/50,000
HB03 350/150W	345x160	150	120/220÷240/100÷277	0,9	18000/19500	120/130	3000/4000/6500	80	90	30,000/50,000
HB03 390/200W	390x160	200	120/220÷240/100÷277	0,9	24000/26000	120/130	3000/4000/6500	80	90	30,000/50,000
HB03 390/250W	395x160	250	120/220÷240/100÷277	0,9	30000/32500	120/130	3000/4000/6500	80	90	30,000/50,000

Capacity: 2.0 million pieces per year

Customizable: Power (100/120/150/200/250W), Voltage (120/220÷240/100÷277), lm/W (up to 140), CCT (3000/4000/6500K), Driver (non-isolation/ isolation), lifespan (30,000/ 50,000 hrs), Beam angle (60/90/120 degree), etc.

LUMINOUS INTENSITY DISTRIBUTION

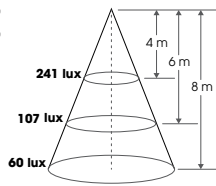
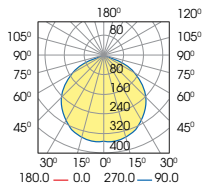
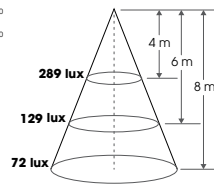
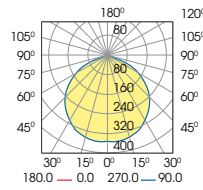
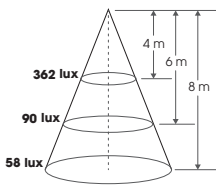
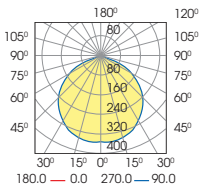
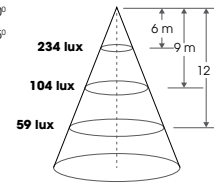
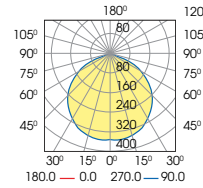
HB03 100W

HB03 120W

HB03 150W

HB03 200W

PACKING AND TRANSPORTATION



Customizable according to customer's request

Type of lamps	Quantity in master box (pcs)	Estimated quantity/ 20'DC (pcs)	Estimated quantity/ 40'HC (pcs)
HB03 290/100W	1	1854	4257
HB03 350_120/150W	1	1425	3272
HB03 390/200/250W	1	1163	2670



Exported market: South Korea, EU, etc



RANG DONG LIGHT SOURCE AND VACUUM FLASK JOINT STOCK COMPANY

Add: 87- 89 Ha Dinh Street, Thanh Xuan, Hanoi, Vietnam

Tel: (84-24) 3 858 4310 / 3 858 4165

Fax: (84-24) 3 858 5038

Email: export@rangdong.com.vn



Specifications are subject to change without prior notice